

IRS2052MPbF 2 CH Digital Audio Amplifier

Features

- 2 channel integrated analog input Class D audio amplifier driver
- Versatile protection control enabling latched, non-latched, or host controlled shutdown function
- Integrated clock oscillator
- Clipping detection
- External thermal sensor input
- On-chip thermal shutdown with warning
- Programmable over current protection
- Programmable dead-time generation
- Start and stop click noise reduction
- Under voltage protection
- High noise immunity

Product Summary

Topology	Half-Bridge
$V_{\text{OFFSET (max)}}$	+/- 100 V
$I_{\text{O+}} & I_{\text{O-}}$ (typical)	0.5 A & 0.6 A
Selectable deadtime	45/65/85/105 ns
DC offset	<20 mV
OC protection delay	500 ns (max)
Shutdown propagation delay	250 ns (max)
Error amplifier open loop gain	>60 dB

Note

The IRS2052M digital audio driver is a two channel version of IRS2092(S) with additional features, such as internal clock and over temperature protection. The IRS2052M features clipping detection outputs, on-chip over temperature detection, over temperature sensor inputs and a fault reporting output.

Package



Typical Connection

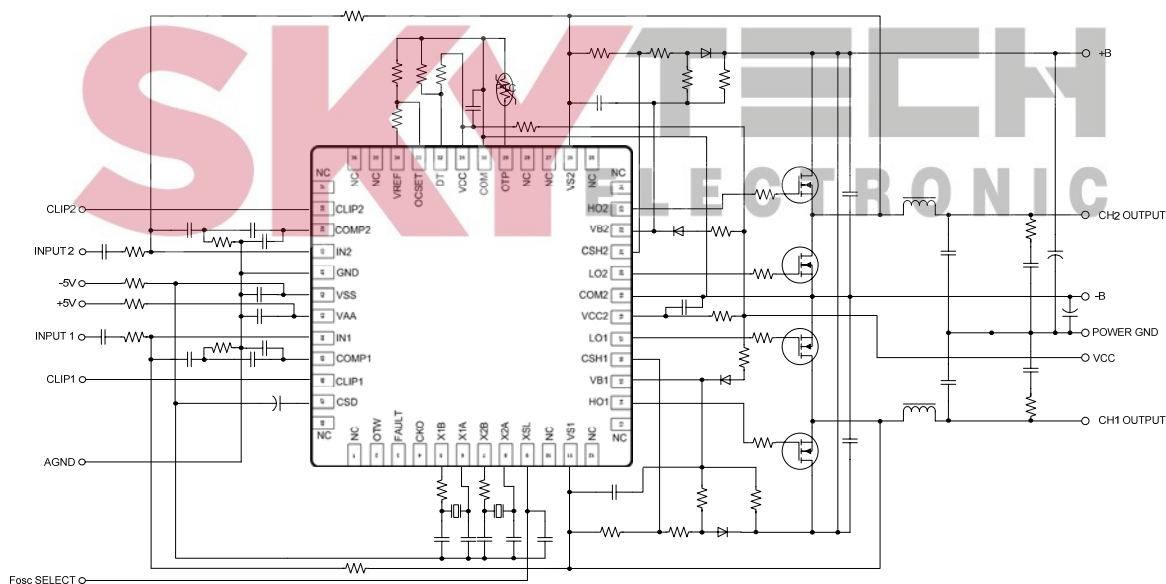

Table of Contents	Page
Typical Connection Diagram	1
Qualification Information	3
Absolute Maximum Ratings	4
Recommended Operating Conditions	6
Electrical Characteristics	7
Functional Block Diagram	12
Input/Output Pin Equivalent Circuit Diagram	13
Lead Definitions	15
Lead Assignments	17
Application Information and Additional Details	18
Package Details	20
Part Marking Information	21
Ordering Information	23
Change History	24



Description

The IRS2052M integrates two channels of high voltage, high performance Class D audio amplifier drivers with PWM modulators and protections. In conjunction with external MOSFET and external components, a complete 2 channel Class D audio amplifier can be realized. The IRS2052M is designed with floating analog inputs and protection control interface pin especially for half bridge topology. High and low side MOSFET are protected from over current conditions by a programmable bi-directional current sensing. Essential elements of PWM modulator section allow flexible system design. A small MLPQ48 package enhances the benefit of smaller size of Class D topology. The IRS2052M is a lead-free, ROHS compliant.

Qualification Information[†]

Qualification Level		Industrial ^{††}
		Comments: This family of ICs has passed JEDEC's Industrial qualification. IR's Consumer qualification level is granted by extension of the higher Industrial level.
Moisture Sensitivity Level		MSL2 ^{†††} , 260°C (per IPC/JEDEC J-STD-020)
ESD	Machine Model	Class B (per JEDEC standard EIA/JESD22-A115)
	Human Body Model	Class 1B (per EIA/JEDEC standard JESD22-A114)
IC Latch-Up Test		Class I, Level A (per JESD78)
RoHS Compliant		Yes

† Qualification standards can be found at International Rectifier's web site <http://www.irf.com/>

†† Higher qualification ratings may be available should the user have such requirements. Please contact your International Rectifier sales representative for further information.

††† Higher MSL ratings may be available for the specific package types listed here. Please contact your International Rectifier sales representative for further information.



Absolute Maximum Ratings

Absolute Maximum Ratings indicate sustained limits beyond which damage to the device may occur. All voltage parameters are absolute voltages referenced to COM; all currents are defined positive into any lead. The Thermal Resistance and Power Dissipation ratings are measured under board mounted and still air conditions.

Symbol	Definition	Min.	Max.	Units
V_{Bn}	High side floating supply voltage	-0.3	215	V
V_{Sn}	High side floating supply voltage ^{††} , n=1-2	$V_{Bn} - 15$	$V_{Bn} + 0.3$	V
V_{Hon}	High side floating output voltage, n=1-2	$V_{Sn} - 0.3$	$V_{Bn} + 0.3$	V
V_{CSHn}	CSH pin input voltage, n=1-2	$V_{Sn} - 0.3$	$V_{Bn} + 0.3$	V
V_{CC}	V_{CC} low side fixed supply voltage ^{††}	-0.3	20	V
V_{CC2}	V_{CC2} low side fixed supply voltage ^{††}	-0.3	20	V
V_{Lon}	Low side output voltage, n=1-2	-0.3	$V_{CC2} + 0.3$	V
V_{AA}	Floating input positive supply voltage ^{††}	(See I_{AAZ})	220	V
V_{SS}	Floating input negative supply voltage ^{††}	-1 (See I_{SSZ})	$V_{AA} + 0.3$	V
V_{GND}	Floating input supply ground voltage	$V_{SS} - 0.3$	$V_{AA} + 0.3$	V
I_{IN-n}	Inverting input current [†] , n=1-2	-	±3	mA
V_{CSD}	SD pin input voltage	$V_{SS} - 0.3$	$V_{AA} + 0.3$	V
V_{COMPn}	COMP pin input voltage, n=1-2	$V_{SS} - 0.3$	$V_{AA} + 0.3$	V
V_{CLIPn}	CLIP pin input voltage	GND - 0.3	$V_{AA} + 0.3$	V
I_{CLIPn}	CLIP pin sinking current	-	5	mA
V_{FAULT}	FAULT pin input voltage	GND - 0.3	$V_{AA} + 0.3$	V
I_{FAULT}	FAULT pin sinking current	-	5	mA
V_{OTW}	OTW pin input voltage	GND - 0.3	$V_{AA} + 0.3$	V
I_{OTW}	OTW pin sinking current	-	5	mA
V_{DT}	DT pin input voltage	-0.3	$V_{CC} + 0.3$	V
V_{OCSET}	OCSET pin input voltage	-0.3	$V_{CC} + 0.3$	V
V_{OTPn}	OTP pin input voltage	-0.3	$V_{CC} + 0.3$	V
I_{AAZ}	Floating input positive supply zener clamp current ^{††}	-	10	mA
I_{CCZ}	Low side V_{CC} supply zener clamp current ^{††}	-	10	mA
I_{CC2Z}	Low side V_{CC2} supply zener clamp current ^{††}	-	10	mA
I_{OTPZ}	OTP pin zener clamping current	-	1	mA
I_{BSZn}	Floating supply zener clamp current ^{††} , n=1-2	-	10	mA
I_{OREF}	Reference output current	-	5	mA
dV_{Sn}/dt	Allowable V_s voltage slew rate, n=1-2	-	50	V/ns
dV_{SS}/dt	Allowable V_{ss} voltage slew rate ^{†††}	-	50	V/ms

Absolute Maximum Ratings (Cont'd)

Symbol	Definition	Min.	Max.	Units
Pd	Maximum power dissipation @ $T_A \leq +25^\circ\text{C}^{\dagger\dagger\dagger}$	-	6	W
RthJA	Thermal resistance, Junction to ambient ^{†††}	-	20	°C/W
Tj	Junction Temperature	-	150	°C
Ts	Storage Temperature	-55	150	°C
Tl	Lead temperature (Soldering, 10 seconds)	-	300	°C

† IN-1 and IN-2 contain clamping diode to GND.

†† VAA-VSS, VCC-COM, VCC2-COM2, VB1-VS1 and VB2-VS2 contain internal shunt zener diodes. Note that the voltage ratings of these can be limited by the clamping current.

††† For the rising and falling edges of step signal of 10V. VSS=15V to 200V.

†††† According to JESD51-5. JEDEC still air chamber.



Recommended Operating Conditions

For proper operation, the device should be used within the recommended conditions below. The V_S and COM offset ratings are tested with supplies biased at $V_{AA}-V_{SS}=10V$, $V_{CC}=V_{CC2}=12V$, $COM2=COM$ and $V_B-V_S=12V$. All voltage parameters are absolute voltages referenced to COM; all currents are defined positive into any lead.

Symbol	Definition	Min.	Max.	Units
V_{Bn}	High side floating supply absolute voltage, n=1-2	$V_{Sn} + 10$	$V_{Sn} + 14$	V
V_{Sn}	High side floating supply offset voltage	†	200	V
V_{AA}	Floating input supply voltage	$V_{SS} + 4.5$	$V_{SS} + 15$	V
I_{AAZ}	Floating input positive supply zener clamp current	1	11	mA
V_{SS}	Floating input supply absolute voltage	0	200	V
V_{Hon}	High side floating output voltage, n=1-2	V_S	V_B	V
V_{CC}	Low side fixed supply voltage	10	15	V
V_{CC2}	Low side fixed supply voltage	10	15	V
$ V_{CC-} - V_{CC2} $	Low side voltages difference	-	1.2	V
V_{Lon}	Low side output voltage, n=1-2	0	V_{CC2}	V
V_{GND}	GND pin input voltage	V_{SS}^{+++}	V_{AA}^{+++}	V
V_{IN-n}	Inverting input voltage, n=1-2	$V_{GND} - 0.5^{+++}$	$V_{GND} + 0.5^{+++}$	V
V_{CSD}	CSD pin input voltage	V_{SS}	V_{AA}	V
V_{COMPn}	COMP pin input voltage, n=1-2	V_{SS}	V_{AA}	V
C_{COMPn}	COMP pin phase compensation capacitor to GND, n=1-2	1	-	nF
V_{DT}	DT pin input voltage	0	V_{CC}	V
I_{OREF}	Reference output current to COM ^{††}	0.3	0.8	mA
V_{OCSET}	OCSET pin input voltage	0.5	5	V
V_{CSHn}	CSH pin input voltage, n=1-2	V_{Sn}	V_{Bn}	V
dV_{SS}/dt	Allowable V_{SS} voltage slew rate upon power-up ⁺⁺⁺⁺	-	50	V/ms
f_{SW}	Switching Frequency	-	800	kHz
T_A	Ambient Temperature	-40	125	°C

† Logic operational for V_{Sn} equal to $-5V$ to $+200V$. Logic state held for V_{Sn} equal to $-5V$ to $-V_{BSn}$.

†† Nominal voltage for V_{REF} is 5.1V. I_{OREF} of 0.3 – 0.8mA dictates total external resistor value on V_{REF} to be 6.3k to 16.7k ohm.

††† GND input voltage is limited by I_{IN-n} .

++++ V_{SS} ramps up from 0V to 200V.

Electrical Characteristics

$V_{CC}=V_{CC2}=V_{BS1}=V_{BS2}=V_{BS3}=V_{BS4}=12V$, $V_{SS}=V_{S1}=V_{S2}=COM=COM2=0V$, $V_{GND}=5V$, $V_{AA}=10V$, $C_L=1nF$ and $T_A=25^{\circ}C$ unless otherwise specified.

Symbol	Definition	Min	Typ	Max	Units	Test Conditions
Low Side Supply 1						
UV _{CC+}	V _{CC} supply UVLO positive threshold	8.4	8.9	9.4	V	
UV _{CC-}	V _{CC} supply UVLO negative threshold	8.2	8.7	9.2	V	
UV _{CC} HYS	UV _{CC} hysteresis	-	0.2	-	V	
I _{QCC}	Low side quiescent current	-	-	5	mA	V _{DT} =V _{CC}
V _{CLAMPL1}	Low side zener diode clamp voltage	19.6	20.4	21.6	V	I _{CC} =10mA
Low Side Supply 2						
I _{QCC2}	Low side quiescent current	-	-	4	mA	
V _{CLAMPL2}	Low side zener diode clamp voltage	19.6	20.4	21.6	V	I _{CC2} =10mA
High Side Floating Supply						
UV _{BS+n}	High side well UVLO positive threshold, n=1-2	8.0	8.5	9.0	V	
UV _{BS-n}	High side well UVLO negative threshold, n=1-2	7.8	8.3	8.8	V	
UV _B HYS _n	UV _B hysteresis, n=1-2	-	0.2	-	V	
I _{QBSn}	High side quiescent current, n=1-2	-	-	1	mA	
I _{LKHn}	High to Low side leakage current, n=1-2	-	-	50	μA	V _{Bn} =V _{Sn} =200V
V _{CLAMP_{Hn}}	High side zener diode clamp voltage, n=1-2	14.7	15.3	16.2	V	I _{BSn} =5mA
Floating Input Supply						
UV _{AA+}	V _{AA} floating supply UVLO positive threshold from V _{SS}	8.2	8.7	9.2	V	GND pin floating
UV _{AA-}	V _{AA} floating supply UVLO negative threshold from V _{SS}	7.7	8.2	8.7	V	GND pin floating
UV _{AA} HYS	UV _{AA} hysteresis	-	0.5	-	V	GND pin floating
I _{QAASD}	Floating Input positive quiescent supply current in shutdown mode	-	1.5	3	mA	V _{CSD} =V _{SS}
I _{QAA10}	Floating Input positive quiescent supply current, positive input	-	7	10	mA	V _{IN} =V _{SS} +5.2V
I _{QAA11}	Floating Input positive quiescent supply current, negative input	-	5	8	mA	V _{IN} =V _{SS} +4.8V
I _{QAAST}	Floating Input positive quiescent supply current in start-up mode	-	8	12	mA	V _{CSD} =V _{SS} +5.0V
I _{LKM}	Floating input side to Low side leakage current	-	-	50	μA	V _{AA} =V _{SS} =V _{GND} =100V
V _{CLAMP_M}	Floating supply zener diode clamp voltage	19.6	20.4	22.6	V	I _{AA} =5mA, V _{CSD} =V _{SS}

Electrical Characteristics (Cont'd)

Symbol	Definition	Min	Typ	Max	Units	Test Conditions
Audio Input (GND=0V, V _{AA} =5V, V _{SS} =-5V, COM=COM2=V _{CC} =V _{CC2} =-5V, V _{S1} =V _{S2} =CSH1=CSH2=-5V, DT=OCSET=-5V)						
V _{Osn}	CHn input offset voltage, n=1-2	-15	0	15	mV	
I _{BINn}	CHn input bias current, n=1-2	-	-	40	nA	
GBWn	CHn small signal bandwidth, n=1-2	-	9	-	MHz	C _{COMPn} =1nF, Rfn=0
V _{COMPn}	CHn OTA Output voltage, n=1-2	V _{AA} -1	-	V _{SS} +1	V	
g _{mn}	CHn OTA transconductance, n=1-2	-	100	-	mS	V _{IN-n} =10mV
G _{Vn}	CHn OTA gain, n=1-2	60	-	-	dB	
V _{Nrmsn}	CHn OTA input noise voltage, n=1-2	-	250	-	mVrms	BW=20kHz, Resolution BW=22Hz Fig.5
SRn	CHn slew rate, n=1-2	-	±5	-	V/us	C _{COMPn} =1nF
CMRRn	CHn common-mode rejection ratio, n=1-2	-	60	-	dB	
PSRRn	CHn supply voltage rejection ratio, n=1-2	-	65	-	dB	
V _{th+CLIPn}	CHn clip detection positive threshold, n=1-2	0.85xV _{AA}	0.90xV _{AA}	0.95xV _{AA}	V	
V _{th-CLIPn}	CHn clip detection negative threshold, n=1-2	0.05xV _{AA}	0.10xV _{AA}	0.15xV _{AA}	V	
t _{CLIPn}	CHn clipping detection propagation delay, n=1-2	-	40	-	ns	Note 1
t _{CLIPmin}	CHn clipping detection minimum output duration	-	3	-	us	Note 1
PWM comparator						
V _{thPWM}	PWM comparator threshold in COMP	-	(V _{AA} - V _{SS})/2	-	V	
f _{OTAn}	CHn COMP pin star-up local oscillation frequency, n=1-3	0.6	1.0	1.5	MHz	V _{CSD} =VSS+5V

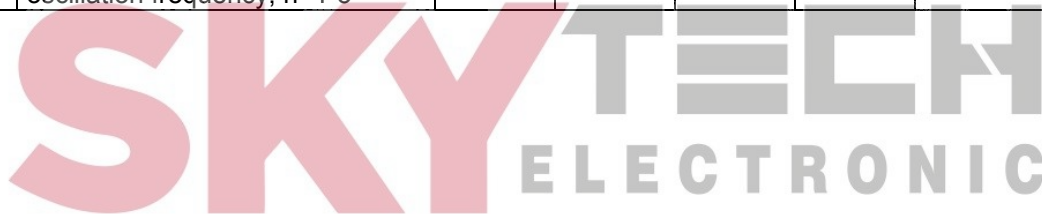

Electrical Characteristics (Cont'd)

Symbol	Definition	Min	Typ	Max	Units	Test Conditions
Clock Oscillator						
$I_{CK1SINK}$, $I_{CK2SINK}$	X1B, X2B pins output sink current at V_{X1B} , $V_{X2B} = 0.5V$	-	-	20	mA	
$I_{CK1SOURC}$ E , $I_{CK2SOURC}$ E	X1B, X2B pins output source current at V_{X1B} , $V_{X2B} = V_{AA} - 0.5V$	-	-	-20	mA	
V_{OLCK1} , V_{OLCK2}	X1B, X2B pins low level output voltage	-	-	0.07	V	
V_{OHCK1} , V_{OHCK2}	X1B, X2B pins high level output voltage	-	-	9.95	V	
V_{ILCK1} , V_{ILCK2}	X1A, X2A pins input low voltage	-	-	2	V	
V_{IHCK1} , V_{IHCK2}	X1A, X2A pins input high voltage	8	-	-	V	
I_{IN1} , I_{IN2}	X1A, X2A pins input current	-	-	+/- 20	uA	
C_{IN1} , C_{IN2}	X1A, X2A pins input capacitance at X1A, X2A pins	-	1	-	pF	Note 1
t_{ONCK1} , t_{OFFCK1} , t_{ONCK2} , t_{OFFCK2}	Propagation delay time from X1A to X1B, X2A to X2B	-	40	-	ns	
$V_{th_{CKSL1}}$	CKSL pin threshold 1	$0.61 \times V_{AA}$	$0.67 \times V_{AA}$	$0.74 \times V_{AA}$	V	
$V_{th_{CKSL2}}$	CKSL pin threshold 2	$0.29 \times V_{AA}$	$0.33 \times V_{AA}$	$0.37 \times V_{AA}$	V	



Electrical Characteristics (Cont'd)

Symbol	Definition	Min	Typ	Max	Units	Test Conditions
Protection						
V _{REF}	Reference output voltage	4.8	5.1	5.4	V	I _{OREF} = 0.5mA
V _{thOCLn}	CHn low side OC threshold in V _{sn} , n=1-2	1.1	1.2	1.3	V	OCSET=1.2V
V _{thOCHn}	CHn high side OC threshold in V _{CShn} , n=1-2	1.1+ V _s	1.2+ V _s	1.3+ V _s	V	V _s =200V,
V _{ETO}	External OTP pin open circuit voltage	4.8	5.1	5.4	V	
V _{ETW}	External OTP pin warning threshold	1.1	1.4	1.6	V	
V _{ETSD}	External OTP pin shutdown threshold	2.3	2.8	3.3	V	
I _{ET}	External OTP bias sourcing current	0.43	0.65	0.87	mA	OTP=0V
T _w	On-chip thermal warning	-	T _{SD} -20	-	°C	Note 1
T _{SD}	ON-chip thermal shutdown	-	150	-	°C	
T _{WHYT}	On-chip thermal warning hysteresis	-	15	-	°C	
T _{SDHYT}	ON-chip thermal shutdown hysteresis	-	15	-	°C	
V _{th1}	CSD pin shutdown release threshold	0.62xV _{AA}	0.70xV _{AA}	0.78xV _{AA}	V	
V _{th2}	CSD pin self reset threshold	0.26xV _{AA}	0.30xV _{AA}	0.34xV _{AA}	V	
I _{CSD+}	CSD pin discharge current	70	100	130	μA	V _{CSD} = V _{SS} + 7.5V
I _{CSD-}	CSD pin charge current	70	100	130	μA	V _{CSD} = V _{SS} + 7.5V
V _{FAULT}	FAULT pin warning output voltage	-	GND	GND +0.1	V	R _{PULL-UP} = 10k
V _{OTW}	OTW pin warning output voltage	-	GND	GND +0.1	V	R _{PULL-UP} = 10k
t _{SSDn}	CHn soft shutdown propagation delay from V _{CSD} < V _{SS} + V _{th1} to Shutdown	-	-	1.4	us	f _{PWM} =400kHz, Fig.2
t _{OCHn}	CHn propagation delay time from V _{CShn} > V _{thOCHn} to Shutdown, n=1-2	-	-	800	ns	Fig.4
t _{OCLn}	CHn propagation delay time from V _{sn} > V _{thOCL} to Shutdown, n=1-2	-	-	700	ns	Fig.3
P _{SD}	Shutdown timing	-	40	-	%	f _{PWM} =400kHz, Duty= 50%, Fig.2

Electrical Characteristics (Cont'd)

Symbol	Definition	Min	Typ	Max	Units	Test Conditions
Gate Driver						
Io+n	CHn output high short circuit current (Source) , n=1-2	-	0.5	-	A	Vo=0V, PW≤10μS, Note 1
Io-n	CHn output low short circuit current (Sink) , n=1-2	-	0.6	-	A	Vo=12V, PW≤10μS, Note 1
VOLn	CHn low level out put voltage LO – COM, HO - VS, n=1-2	-	-	0.1	V	Io=0A
VOHn	CHn high level out put voltage VCC – LO, VB - HO, n=1-2	-	-	1.4	V	
Ton0n	CHn high and low side turn-on propagation delay, n=1-2	-	350	-	ns	V _{DT} = V _{CC}
Toff0n	CHn high and low side turn-off propagation delay, n=1-2	-	325	-	ns	
tr	Turn-on rise time	-	25	50	ns	
tf	Turn-off fall time	-	20	40	ns	
DT1n	CHn deadtime: LOn turn-off to HOn turn-on (DT _{LO-HO}) & HOn turn-off to LnO turn-on (DT _{HO-LO})	30	45	60	ns	V _{DT} >V _{DT1} ,
DT2n	CHn deadtime: LOn turn-off to HOn turn-on (DT _{LO-HO}) & HOn turn-off to LOn turn-on (DT _{HO-LO})	45	65	85	ns	V _{DT1} >V _{DT} > V _{DT2} ,
DT3n	CHn deadtime: LOn turn-off to HOn turn-on (DT _{LO-HO}) & HOn turn-off to LOn turn-on (DT _{HO-LO})	60	85	110	ns	V _{DT2} >V _{DT} > V _{DT3} ,
DT4n	CHn deadtime: LOn turn-off to HOn turn-on (DT _{LO-HO}) & HO turn-off to LOn turn-on (DT _{HO-LO}) V _{DT} = V _{DT4}	80	105	145	ns	V _{DT} <V _{DT3}
V _{DT1}	DT mode select threshold 1	0.51xVcc	0.57xVcc	0.63xVcc	V	
V _{DT2}	DT mode select threshold 2	0.32xVcc	0.36xVcc	0.40xVcc	V	
V _{DT3}	DT mode select threshold 3	0.21xVcc	0.23xVcc	0.25xVcc	V	

Note 1 Guaranteed by design, but not tested in production.

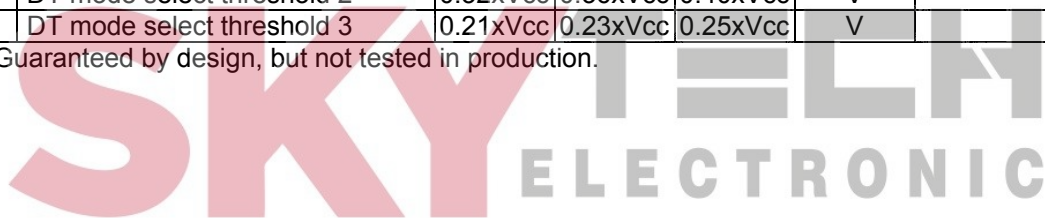

Functional Block Diagram

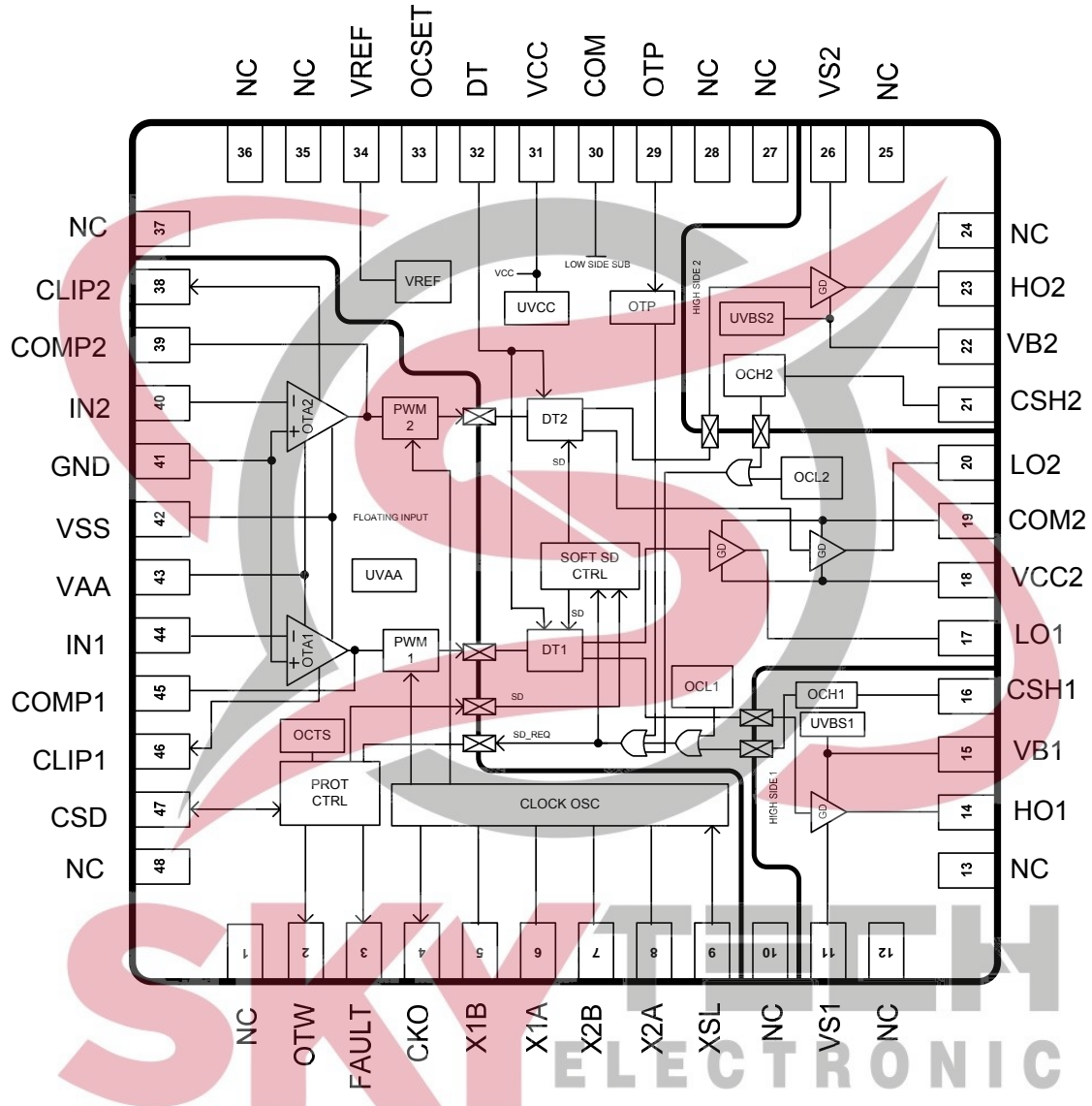

Input/Output Pin Equivalent Circuit Diagrams

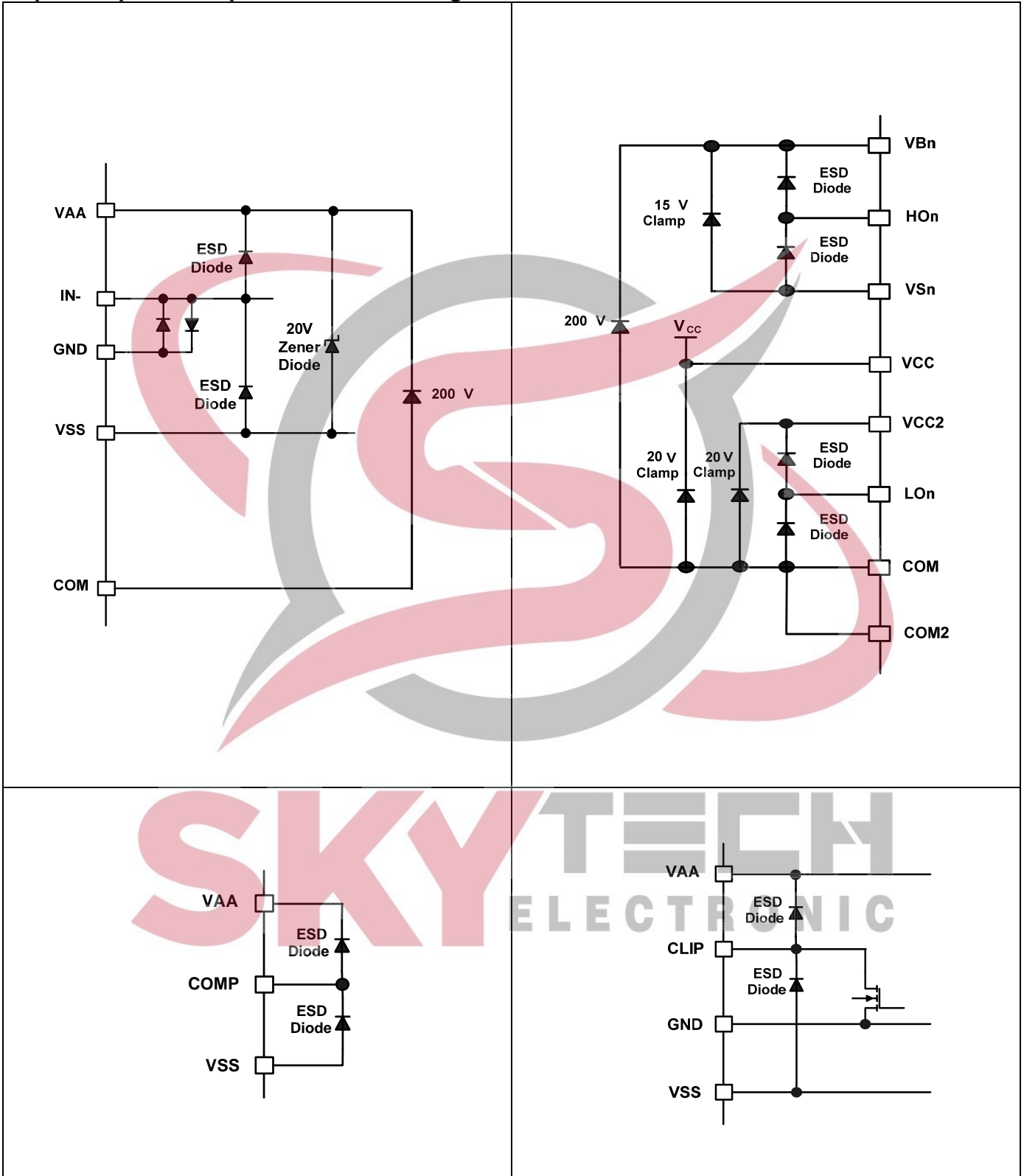

Input/Output Pin Equivalent Circuit Diagrams (Cont'd)

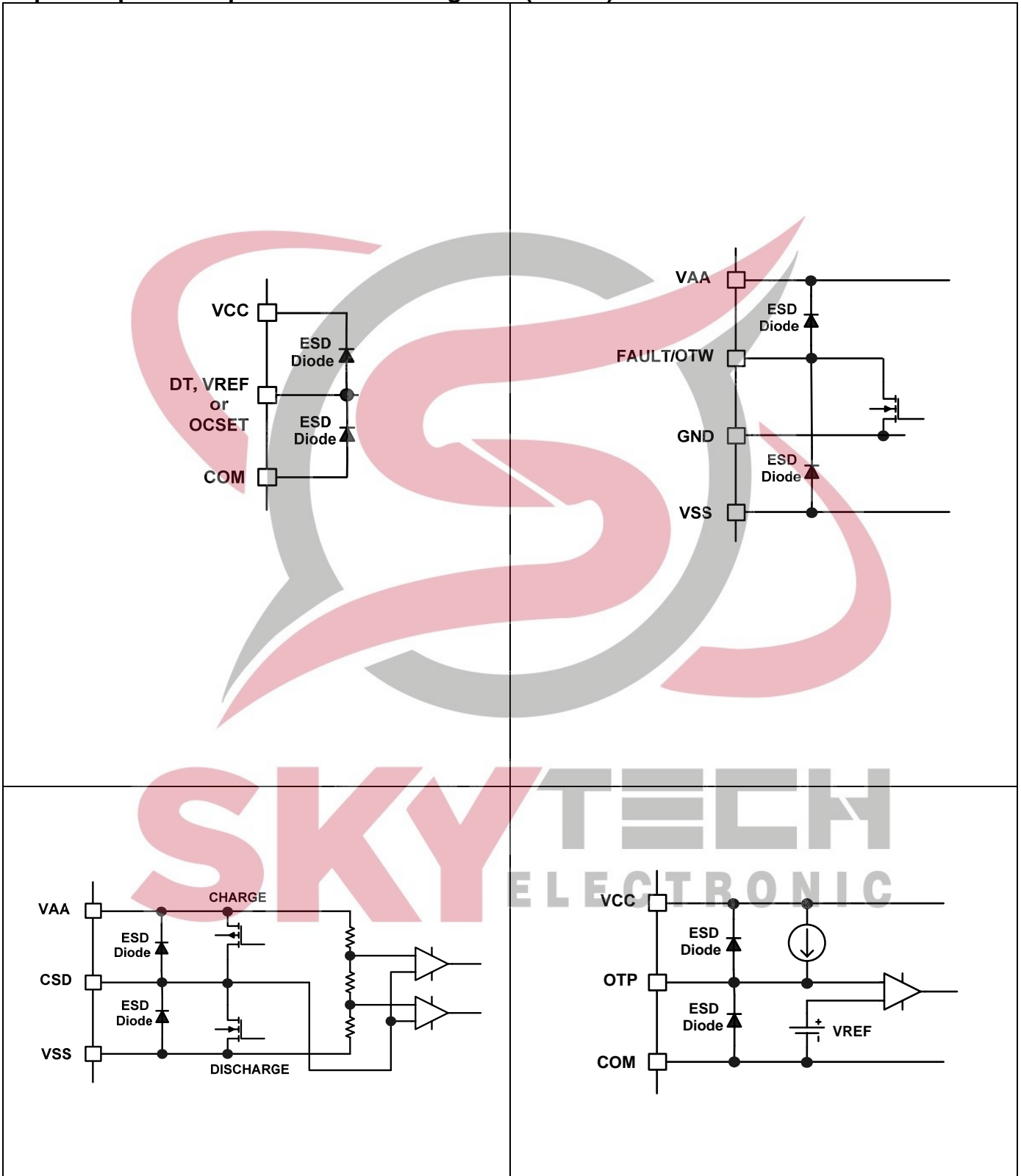

Lead Definitions

Pin #	Symbol	I/O	Description
1	NC		
2	OTW	O	On-chip over temperature warning output
3	FAULT	O	Fault reporting output
4	CKO	O	Clock output
5	X1B	O	Clock oscillator output 1
6	X1A	I	Clock oscillator input 1
7	X2B	O	Clock oscillator output 2
8	X2A	I	Clock oscillator input 2
9	XSL	I	Clock oscillator select (VAA: osc 1, GND: osc 2, VSS: No sync)
10	NC		
11	VS1	I	CH1 High side floating supply return
12	NC		
13	NC		
14	HO1	O	CH1 High side output
15	VB1	I	CH1 High side floating supply
16	CSH1	I	CH1 High side over current sensing input, referenced to VS1
17	LO1	O	CH1 Low side output
18	VCC2	I	Low side gate drive supply
19	COM2	I	Low side gate drive supply return
20	LO2	O	CH2 Low side output
21	CSH2	I	CH2 High side over current sensing input, referenced to VS2
22	VB2	I	CH2 High side floating supply
23	HO2	O	CH2 High side output
24	NC		



Lead Definitions (Cont'd)

Pin #	Symbol	I/O	Description
25	NC		
26	VS2	I	CH2 High side floating supply return
27	NC		
28	NC		
29	OTP	I	Over temperature sensor input, referenced to COM
30	COM	I	Low side gate drive supply return
31	VCC	I	Low side gate drive supply
32	DT	I	Deadtime program, reference to COM
33	OCSET	I	Low side OCP threshold, referenced to COM
34	VREF	O	5.1V reference voltage output for OCSET
35	NC		
36	NC		
37	NC		
38	CLIP2	O	Clipping detection output CH2, open drain, referenced to GND
39	COMP2	O	CH2 PWM comparator input
40	IN2	I	CH2 inverting audio input
41	GND	I	Input reference GND
42	VSS	I	Floating input negative supply
43	VAA	I	Floating input positive supply
44	IN1	I	CH1 inverting audio input
45	COMP1	O	CH1 PWM comparator input
46	CLIP1	O	Clipping detection output CH1, open drain, referenced to GND
47	CSD	I/O	Protection control
48	NC		



Lead Assignments (MLPQ48_7x7mm)

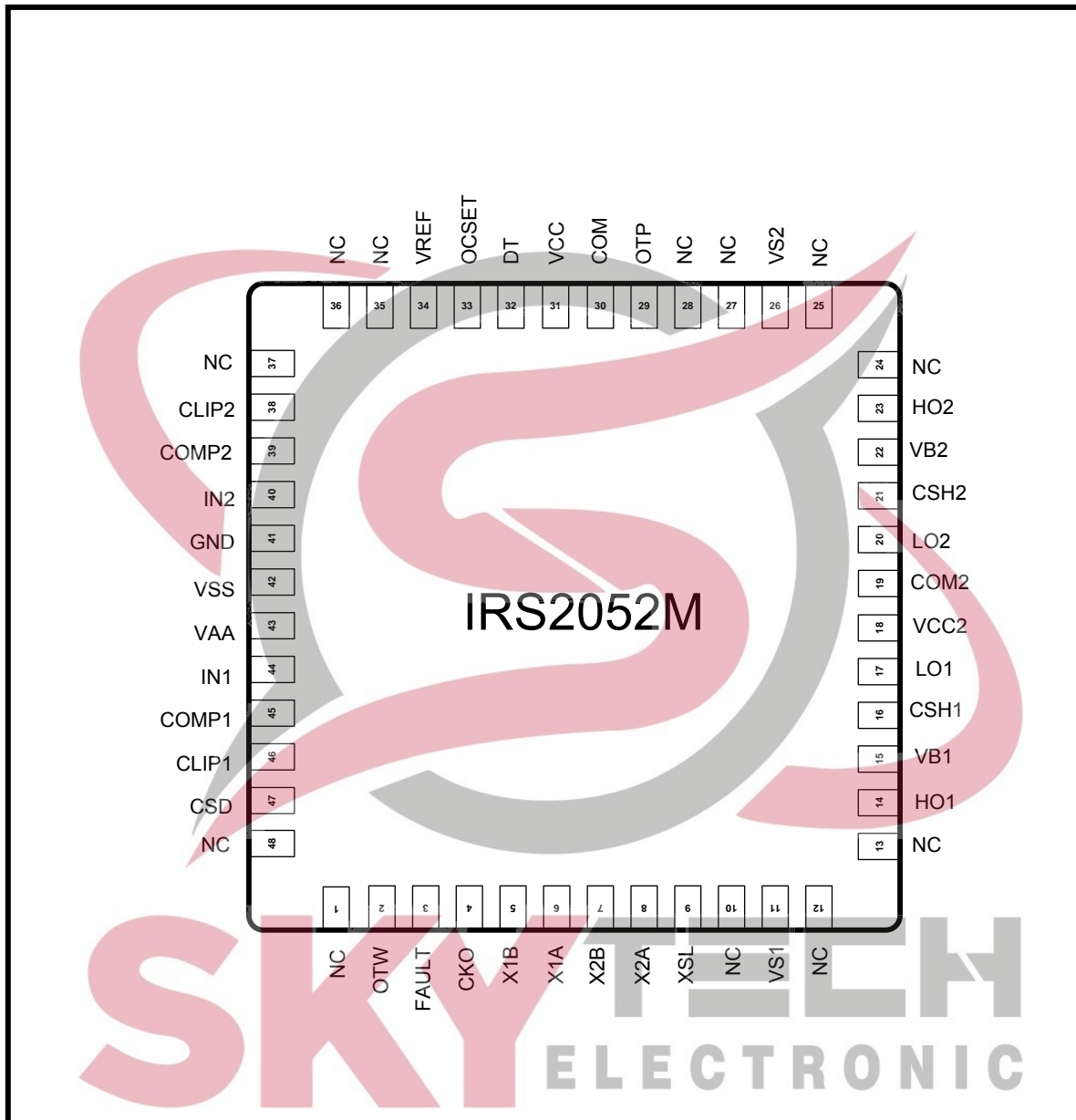

Application Information and Additional Details

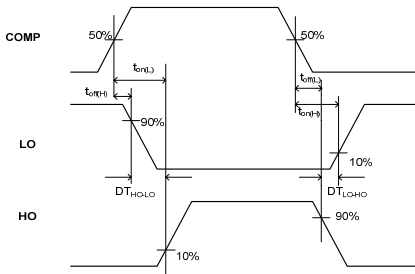

Figure 1 Switching Time Waveform Definitions

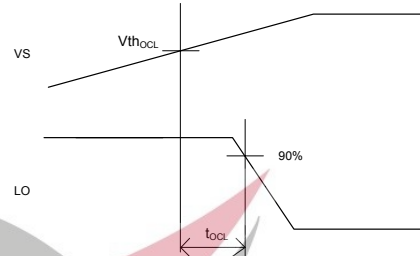

Figure 3 $V_s > V_{thOCL}$ to Shutdown Waveform

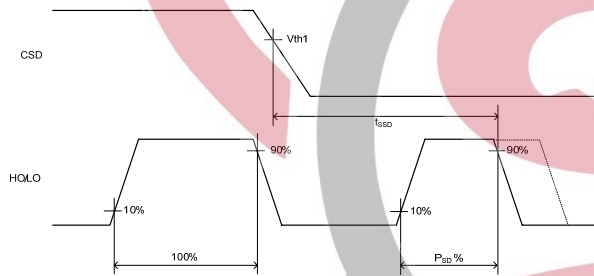

Figure 2 CSD to Shutdown Waveform Definitions

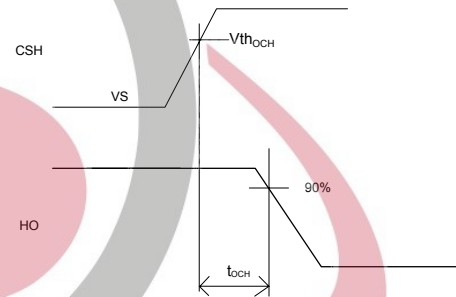

Figure 4 $V_{CSH} > V_{thOCH}$ to Shutdown Waveform



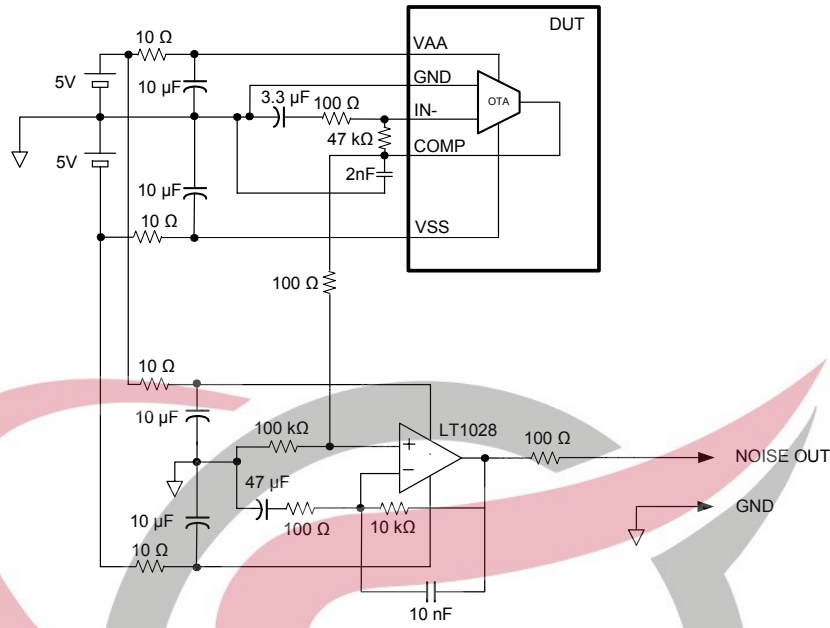
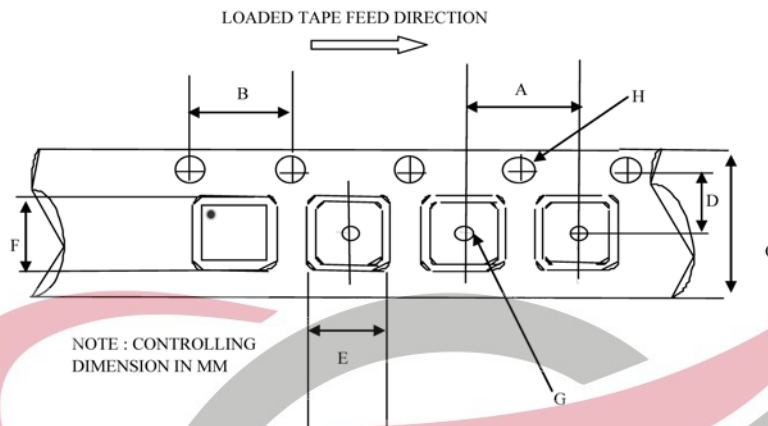

Figure 5: OTA input noise voltage mesurent circuit



Tape and Reel Details: MLPQ 7X7



CARRIER TAPE DIMENSION FOR 48MLPQ7X7

Code	Metric		Imperial	
	Min	Max	Min	Max
A	11.90	12.10	0.474	0.476
B	3.90	4.10	0.153	0.161
C	15.70	16.30	0.618	0.641
D	7.40	7.60	0.291	0.299
E	7.15	7.35	0.281	0.289
F	7.15	7.35	0.281	0.289
G	1.50	n/a	0.059	n/a
H	1.50	1.60	0.059	0.062

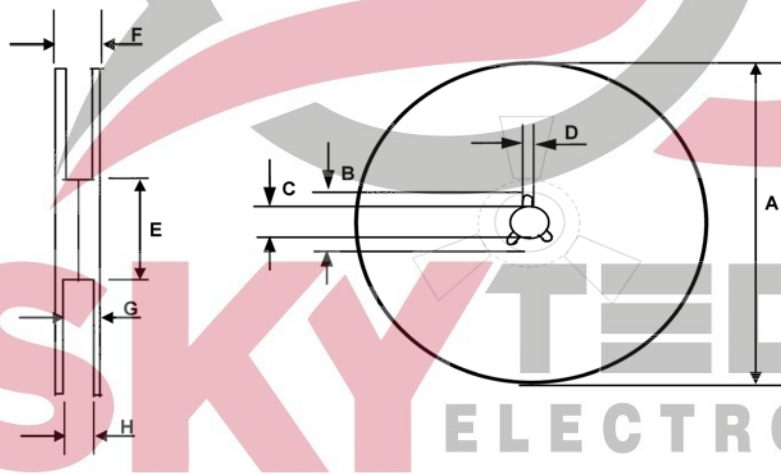

REEL DIMENSIONS FOR 48MLPQ7X7

Code	Metric		Imperial	
	Min	Max	Min	Max
A	329.60	330.25	12.976	13.001
B	20.95	21.45	0.824	0.844
C	12.80	13.20	0.503	0.519
D	1.95	2.45	0.767	0.096
E	98.00	102.00	3.858	4.015
F	n/a	22.4	n/a	0.881
G	18.5	21.1	0.728	0.83
H	16.4	18.4	0.645	0.724

Part Marking Information

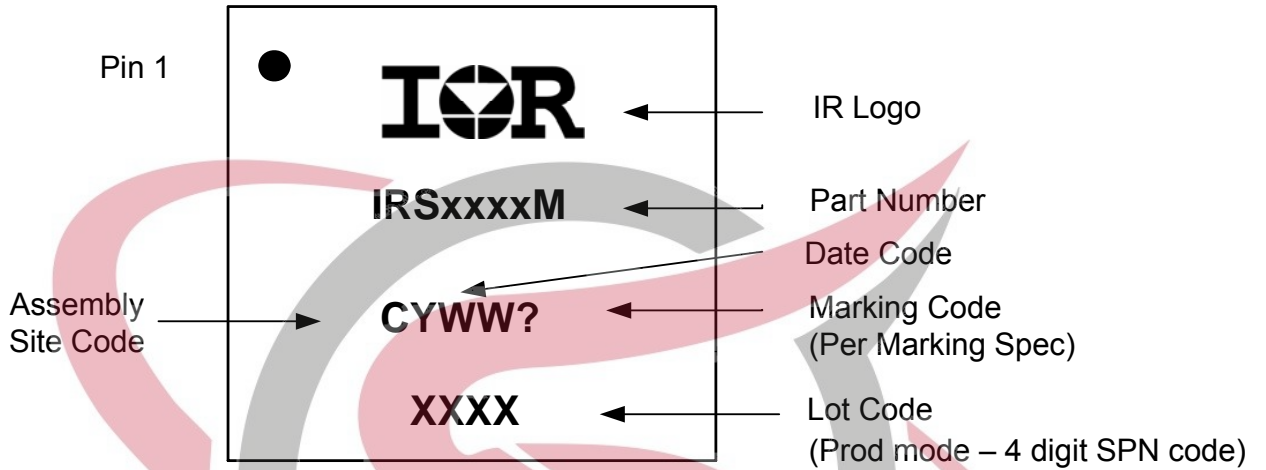

SKYTECH
ELECTRONIC

Ordering Information

Base Part Number	Package Type	Standard Pack		Complete Part Number
		Form	Quantity	
IRS2052M	MLPQ 48 7x7	Tape and Reel	3000	IRS2052MTRPBF



The information provided in this document is believed to be accurate and reliable. However, International Rectifier assumes no responsibility for the consequences of the use of this information. International Rectifier assumes no responsibility for any infringement of patents or of other rights of third parties which may result from the use of this information. No license is granted by implication or otherwise under any patent or patent rights of International Rectifier. The specifications mentioned in this document are subject to change without notice. This document supersedes and replaces all information previously supplied.

For technical support, please contact IR's Technical Assistance Center
<http://www.irf.com/technical-info/>

WORLD HEADQUARTERS:
 233 Kansas St., El Segundo, California 90245
 Tel: (310) 252-7105